



FSP Expert 1/2/3/4/5k PVInverter

User Manual

Version: 2.0

Table Of Contents

ABOUT THIS MANUAL	1
Purpose.....	1
Scope.....	1
SAFETY INSTRUCTIONS	1
INTRODUCTION	2
Features.....	2
Basic System Architecture	2
Product Overview.....	3
INSTALLATION	4
Unpacking and Inspection.....	4
Preparation	4
Mounting the Unit.....	4
Battery Connection	5
AC Input/Output Connection.....	7
PV Connection (Only apply for the model with solar charger).....	9
Final Assembly.....	10
Communication Connection.....	11
Dry Contact Signal	11
OPERATION	12
Power ON/OFF	12
Operation and Display Panel	12
LCD Display Icons	13
LCD Setting.....	15
Display Setting	23
Operating Mode Description	25
Fault Reference Code.....	27
Warning Indicator.....	27
SPECIFICATIONS	28
Table 1 Line Mode Specifications	28
Table 2 Inverter Mode Specifications	29
Table 3 Charge Mode Specifications	30
Table 4 General Specifications	30
TROUBLE SHOOTING	31
Appendix: Approximate Back-up Time Table	32

ABOUT THIS MANUAL

Purpose

This manual describes the assembly, installation, operation and troubleshooting of this unit. Please read this manual carefully before installations and operations. Keep this manual for future reference.

Scope

This manual provides safety and installation guidelines as well as information on tools and wiring.

SAFETY INSTRUCTIONS



WARNING: This chapter contains important safety and operating instructions. Read and keep this manual for future reference.

1. Before using the unit, read all instructions and cautionary markings on the unit, the batteries and all appropriate sections of this manual.
2. **CAUTION** --To reduce risk of injury, charge only deep-cycle lead acid type rechargeable batteries. Other types of batteries may burst, causing personal injury and damage.
3. Do not disassemble the unit. Take it to a qualified service center when service or repair is required. Incorrect re-assembly may result in a risk of electric shock or fire.
4. To reduce risk of electric shock, disconnect all wirings before attempting any maintenance or cleaning. Turning off the unit will not reduce this risk.
5. **CAUTION** – Only qualified personnel can install this device with battery.
6. **NEVER** charge a frozen battery.
7. For optimum operation of this inverter/charger, please follow required spec to select appropriate cable size. It's very important to correctly operate this inverter/charger.
8. Be very cautious when working with metal tools on or around batteries. A potential risk exists to drop a tool to spark or short circuit batteries or other electrical parts and could cause an explosion.
9. Please strictly follow installation procedure when you want to disconnect AC or DC terminals. Please refer to INSTALLATION section of this manual for the details.
10. Fuses (4 pieces of 40A, 32VDC for 1KVA/2KVA, 6 pieces of 40A, 32VDC for 3KVA, 1 piece of 200A, 64VDC for 4KVA and 5KVA) are provided as over-current protection for the battery supply.
11. GROUNDING INSTRUCTIONS -This inverter/charger should be connected to a permanent grounded wiring system. Be sure to comply with local requirements and regulation to install this inverter.
12. NEVER cause AC output and DC input short circuited. Do NOT connect to the mains when DC input short circuits.
13. **Warning!!** Only qualified service persons are able to service this device. If errors still persist after following troubleshooting table, please send this inverter/charger back to local dealer or service center for maintenance.

INTRODUCTION

This is a multi-function inverter/charger, combining functions of inverter, solar charger and battery charger to offer uninterruptible power support with portable size. Its comprehensive LCD display offers user-configurable and easy-accessible button operation such as battery charging current, AC/solar charger priority, and acceptable input voltage based on different applications.

Features

- Pure sine wave inverter
- Configurable input voltage range for home appliances and personal computers via LCD setting
- Configurable battery charging current based on applications via LCD setting
- Configurable AC/Solar Charger priority via LCD setting
- Compatible to mains voltage or generator power
- Auto restart while AC is recovering
- Overload/ Over temperature/ short circuit protection
- Smart battery charger design for optimized battery performance
- Cold start function

Basic System Architecture

The following illustration shows basic application for this inverter/charger. It also includes following devices to have a complete running system:

- Generator or Utility.
- PV modules (option)

Consult with your system integrator for other possible system architectures depending on your requirements.

This inverter can power all kinds of appliances in home or office environment, including motor-type appliances such as tube light, fan, refrigerator and air conditioner.

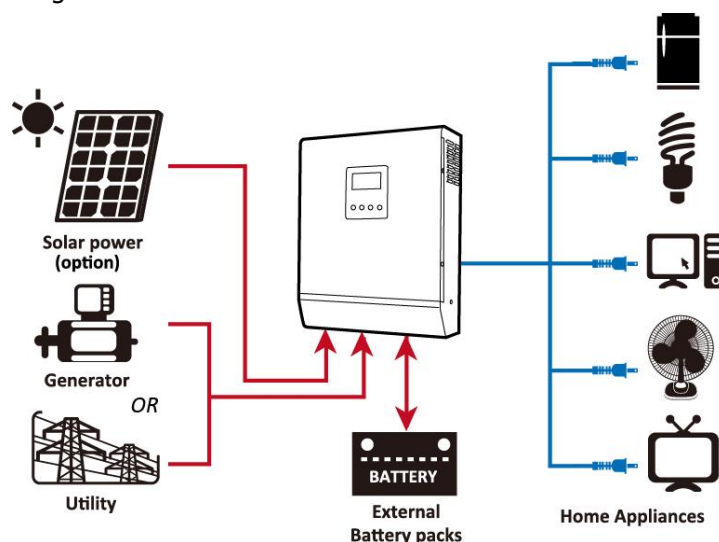
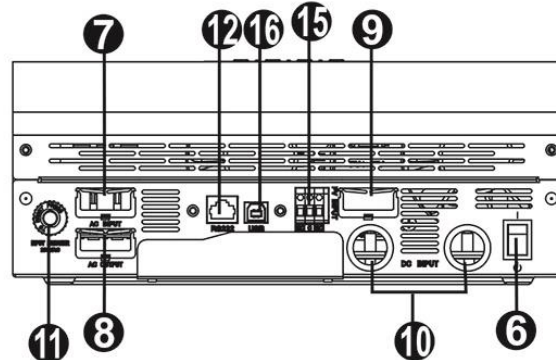
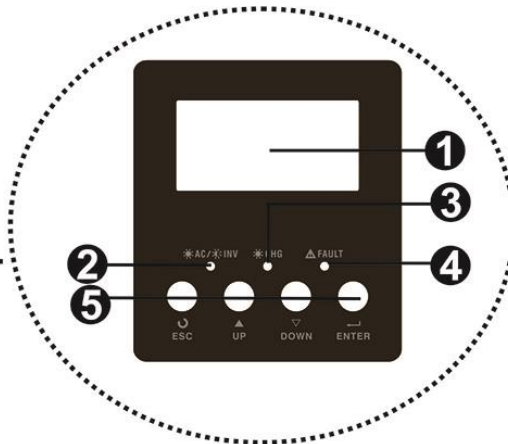
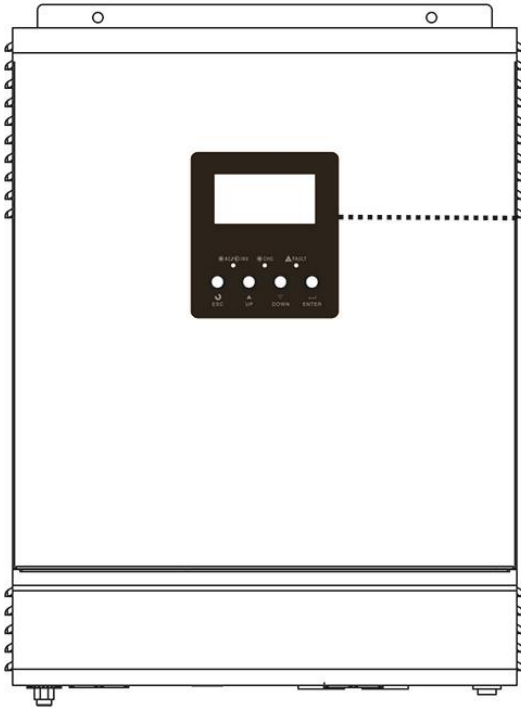
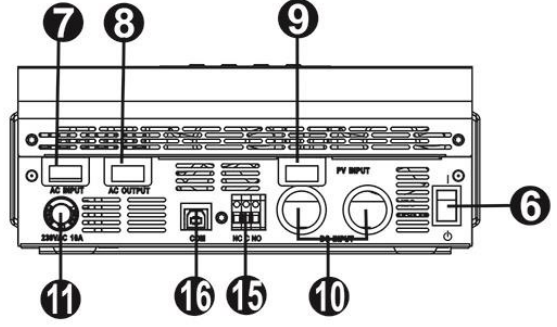

Figure 1 Expert Power System

Product Overview



4KVA/5KVA single model



1KVA model

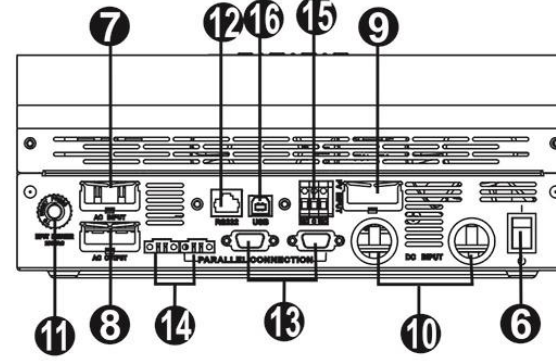

4KVA/5KVA parallel model

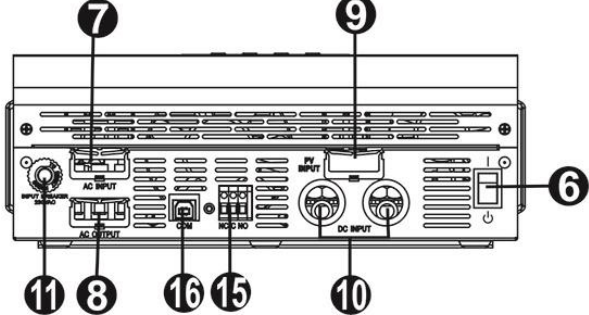

2KVA/3KVA model

NOTE: For parallel model installation and operation, please check separate parallel installation guide for the details.

1. LCD display
2. Status indicator
3. Charging indicator
4. Fault indicator
5. Function buttons
6. Power on/off switch
7. AC input
8. AC output
9. PV input
10. Battery input
11. Circuit breaker
12. RS232 communication port
13. Parallel communication cable (only for parallel model)
14. Current sharing cable (only for parallel model)
15. Dry contact
16. USB communication port

INSTALLATION

Unpacking and Inspection

Before installation, please inspect the unit. Be sure that nothing inside the package is damaged. You should have received the following items inside of package:

- The unit x 1
- User manual x 1
- Communication cable x 1
- Software CD x 1

Preparation

Before connecting all wirings, please take off bottom cover by removing two screws as shown below.

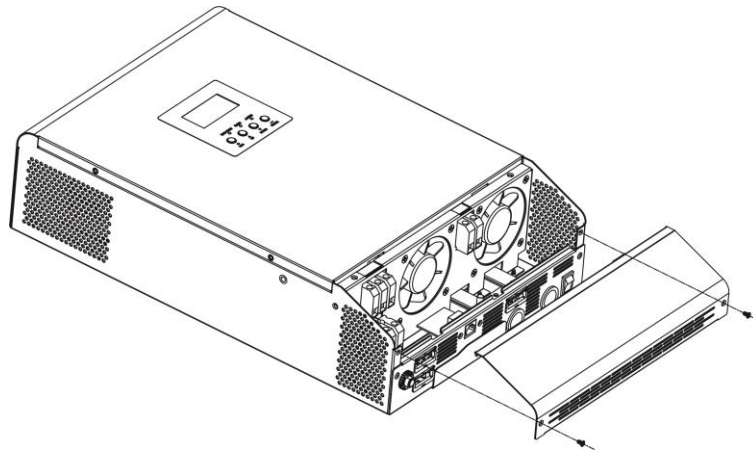

Mounting the Unit

Consider the following points before selecting where to install:

- Do not mount the inverter on flammable construction materials.
- Mount on a solid surface
- Install this inverter at eye level in order to allow the LCD display to be read at all times.
- For proper air circulation to dissipate heat, allow a clearance of approx. 20 cm to the side and approx. 50 cm above and below the unit.
- The ambient temperature should be between 0°C and 55°C to ensure optimal operation.
- The recommended installation position is to be adhered to the wall vertically.
- Be sure to keep other objects and surfaces as shown in the diagram to guarantee sufficient heat dissipation and to have enough space for removing wires.

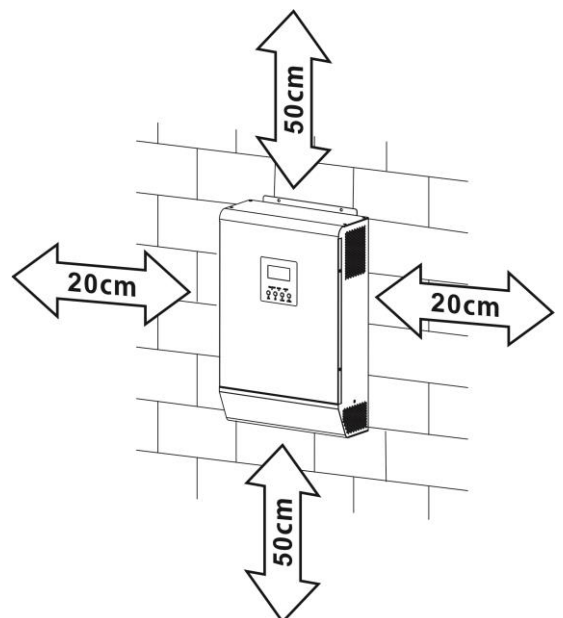

SUITABLE FOR MOUNTING ON CONCRETE OR OTHER NON-COMBUSTIBLE SURFACE ONLY.

Install the unit by screwing three screws. It's recommended to use M4 or M5 screws.

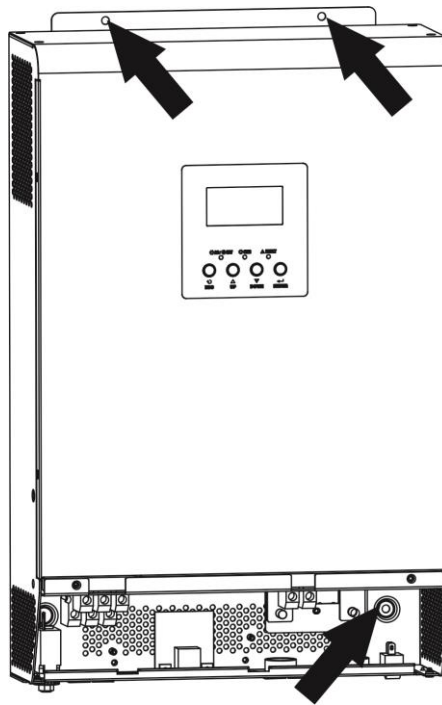

Battery Connection

CAUTION: For safety operation and regulation compliance, it's requested to install a separate DC over-current protector or disconnect device between battery and inverter. It may not be requested to have a disconnect device in some applications, however, it's still requested to have over-current protection installed. Please refer to typical amperage in below table as required fuse or breaker size.

WARNING! All wiring must be performed by a qualified personnel.

WARNING! It's very important for system safety and efficient operation to use appropriate cable for battery connection. To reduce risk of injury, please use the proper recommended cable and terminal size as below.

Ring terminal:

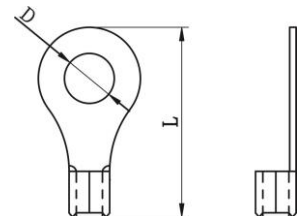

Recommended battery cable and terminal size:

Model	Typical Amperage	Battery capacity	Wire Size	Ring Terminal		Torque value	
				Cable mm ²	Dimensions		
					D (mm)		L (mm)
1KVA/2KVA	66A	100AH	1*6AWG	14	6.4	29.2	2~ 3 Nm
			2*10AWG	8	6.4	23.8	
3KVA	100A	100AH 200AH	1*4AWG	22	6.4	33.2	2~ 3 Nm
			2*8AWG	14	6.4	29.2	
4KVA	110A	200AH	1*2AWG	38	6.4	39.2	2~ 3 Nm
			2*6AWG	28	6.4	33.2	
5KVA	110A	200AH	1*2AWG	38	6.4	39.2	2~ 3 Nm
			2*6AWG	28	6.4	33.2	

Please follow below steps to implement battery connection:

1. Assemble battery ring terminal based on recommended battery cable and terminal size.
2. 1KVA model supports 12VDC system, 2KVA/3KVA model supports 24VDC system and 4KVA/5KVA model supports 48VDC system. Connect all battery packs as below chart. It's suggested to connect at least 100Ah

capacity battery for 1-3KVA model and at least 200Ah capacity battery for 4KVA/5KVA model.

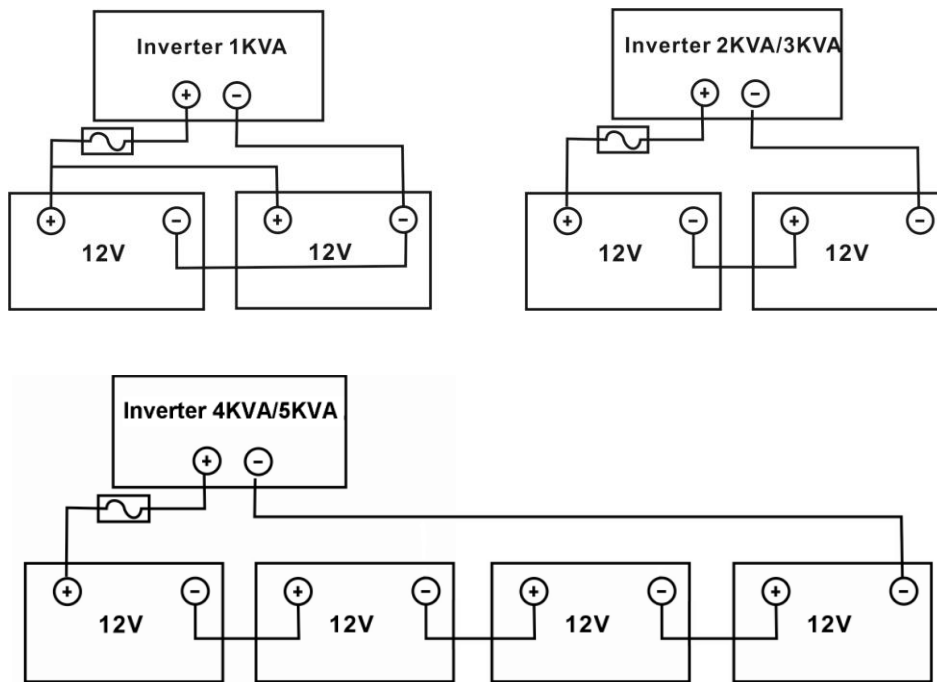

3. Insert the ring terminal of battery cable flatly into battery connector of inverter and make sure the bolts are tightened with torque of 2-3 Nm. Make sure polarity at both the battery and the inverter/charge is correctly connected and ring terminals are tightly screwed to the battery terminals.

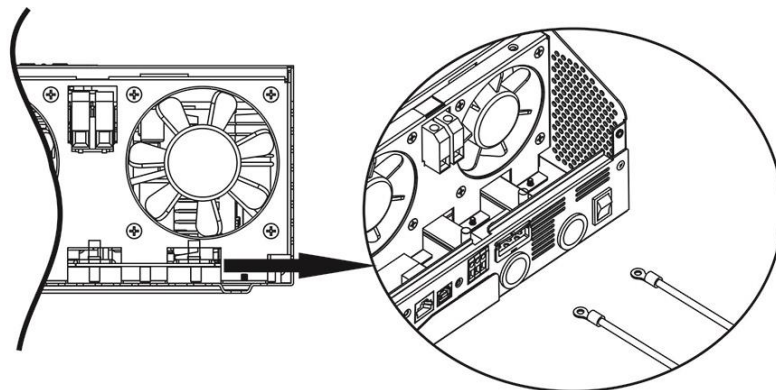

	<p>WARNING: Shock Hazard Installation must be performed with care due to high battery voltage in series.</p>
---	---

	<p>CAUTION!! Do not place anything between the flat part of the inverter terminal and the ring terminal. Otherwise, overheating may occur.</p> <p>CAUTION!! Do not apply anti-oxidant substance on the terminals before terminals are connected tightly.</p> <p>CAUTION!! Before making the final DC connection or closing DC breaker/disconnector, be sure positive (+) must be connected to positive (+) and negative (-) must be connected to negative (-).</p>
---	---

AC Input/Output Connection

CAUTION!! Before connecting to AC input power source, please install a **separate** AC breaker between inverter and AC input power source. This will ensure the inverter can be securely disconnected during maintenance and fully protected from over current of AC input. The recommended spec of AC breaker is 10A for 1KVA, 20A for 2KVA, 32A for 3KVA , 40A for 4KVA and 50A for 5KVA.

CAUTION!! There are two terminal blocks with "IN" and "OUT" markings. Please do NOT mis-connect input and output connectors.

WARNING! All wiring must be performed by a qualified personnel.

WARNING! It's very important for system safety and efficient operation to use appropriate cable for AC input connection. To reduce risk of injury, please use the proper recommended cable size as below.

Suggested cable requirement for AC wires

Model	Gauge	Torque Value
1KVA	16 AWG	0.5~ 0.6 Nm
2KVA	14 AWG	0.8~ 1.0 Nm
3KVA	12 AWG	1.2~ 1.6 Nm
4KVA	10 AWG	1.4~1.6Nm
5KVA	8 AWG	1.4~1.6Nm

Please follow below steps to implement AC input/output connection:

1. Before making AC input/output connection, be sure to open DC protector or disconnecter first.
2. Remove insulation sleeve 10mm for six conductors. And shorten phase L and neutral conductor N 3 mm.
3. Insert AC input wires according to polarities indicated on terminal block and tighten the terminal screws. Be sure to connect PE protective conductor (⊕) first.

⊕→**Ground (yellow-green)**

L→**LINE (brown or black)**

N→**Neutral (blue)**

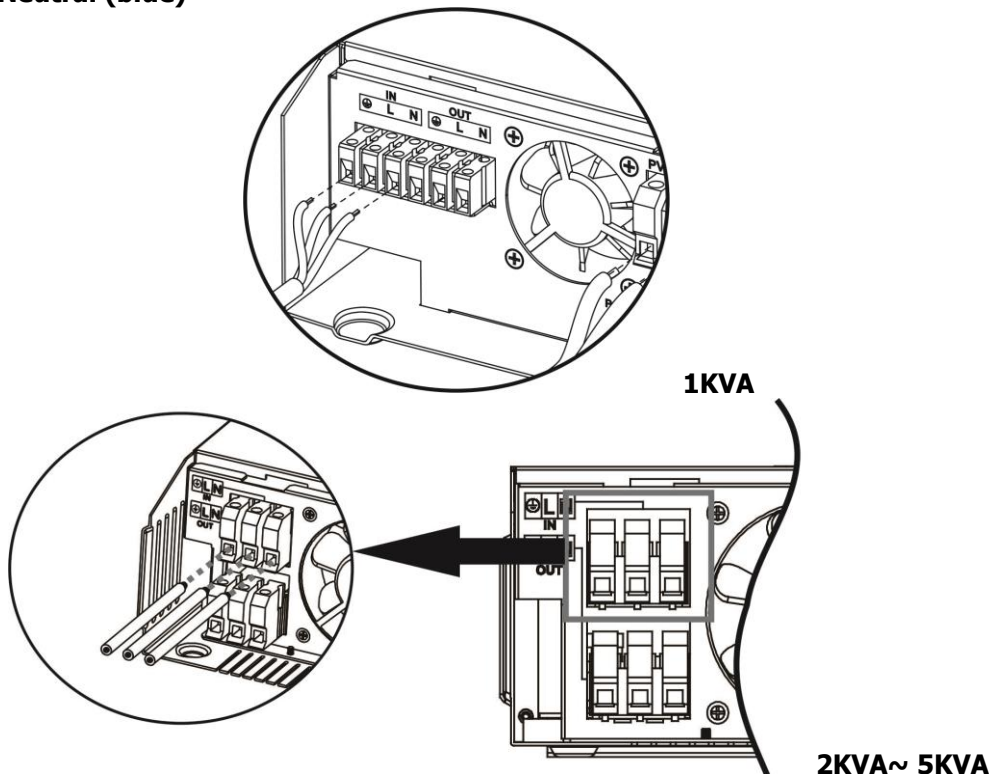



WARNING:

Be sure that AC power source is disconnected before attempting to hardwire it to the unit.

4. Then, insert AC output wires according to polarities indicated on terminal block and tighten terminal screws. Be sure to connect PE protective conductor (⊕) first.



→ **Ground (yellow-green)**

L → **LINE (brown or black)**

N → **Neutral (blue)**

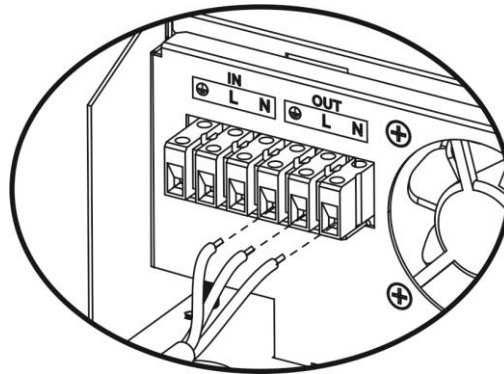

1KVA

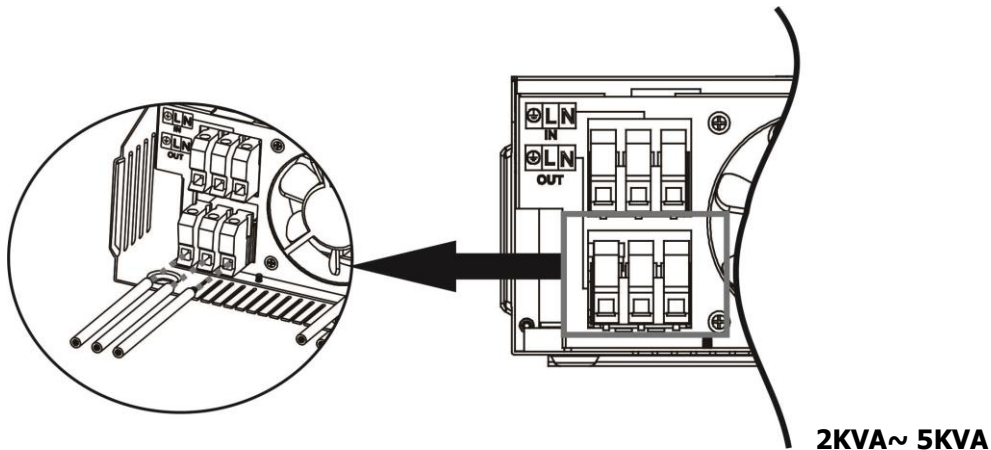

2KVA~ 5KVA

5. Make sure the wires are securely connected.

CAUTION: Important

Be sure to connect AC wires with correct polarity. If L and N wires are connected reversely, it may cause utility short-circuited when these inverters are worked in parallel operation.

CAUTION: Appliances such as air conditioner are required at least 2~3 minutes to restart because it's required to have enough time to balance refrigerant gas inside of circuits. If a power shortage occurs and recovers in a short time, it will cause damage to your connected appliances. To prevent this kind of damage, please check manufacturer of air conditioner if it's equipped with time-delay function before installation. Otherwise, this inverter/charger will trig overload fault and cut off output to protect your appliance but sometimes it still causes internal damage to the air conditioner.

PV Connection (Only apply for the model with solar charger)

CAUTION: Before connecting to PV modules, please install **separately** a DC circuit breaker between inverter and PV modules.

WARNING! All wiring must be performed by a qualified personnel.

WARNING! It's very important for system safety and efficient operation to use appropriate cable for PV module connection. To reduce risk of injury, please use the proper recommended cable size as below.

Typical Amperage	Gauge	Torque Value
50A	8 AWG	1.4~1.6 Nm

PV Module Selection:

When selecting proper PV modules, please be sure to consider below requirements first:

1. Open circuit Voltage (Voc) of PV modules not exceeds max. PV array open circuit voltage of inverter.

INVERTER MODEL	1KVA	2KVA	3KVA	4KVA	5KVA
Solar Charger					
Charging Current (PWM)	50Amp				
System DC Voltage	12Vdc	24Vdc		48Vdc	
Operating Voltage Range	15~18Vdc	30~32Vdc		60~72vdc	
Max. PV Array Open Circuit Voltage	50Vdc	60Vdc		105Vdc	

2. Max. Power Voltage (Vmpp) of PV modules should be close to best Vmp of inverter or within Vmp range to get best performance. If one PV module can not meet this requirement, it's necessary to have several PV modules in series connection. Refer to below table.

Model	Best Vmp	Vmp range
1KVA	15Vdc	15V~18V
2KVA/3KVA	30Vdc	30V~32V
4KVA/5KVA	60Vdc	56V~72V

Note: * Vmp: panel max power point voltage.

The PV charging efficiency is maximized while PV system voltage is close to Best Vmp.

Maximum PV module numbers in Series: V_{mpp} of PV module * X pcs \approx Best Vmp of Inverter or Vmp range

PV module numbers in Parallel: Max. charging current of inverter / I_{mpp}

Total PV module numbers = maximum PV module numbers in series * PV module numbers in parallel

Take 1KVA inverter as an example to select proper PV modules. After considering Voc of PV module not exceeds 50Vdc and max. Vmpp of PV module close to 15Vdc or within 13Vdc ~ 18Vdc, we can choose PV module with below specification.

Maximum Power (Pmax)	85W	Max. PV module numbers in series 1 \rightarrow 17.6 x 1 \approx 15 ~ 18
Max. Power Voltage Vmpp(V)	17.6V	
Max. Power Current Impp(A)	4.83A	PV module numbers in parallel 10 \rightarrow 50 A / 4.83
Open Circuit Voltage Voc(V)	21.6V	
Short Circuit Current Isc(A)	5.03A	Total PV module numbers 1 x 10 = 10

Maximum PV module numbers in Series: 1

PV module numbers in Parallel: 10

Total PV module numbers: 1 x 10 = 10

Take 2K/3KVA inverter as an example to select proper PV module. After considering Voc of PV module not exceed 60Vdc and max. Vmpp of PV module close to 30Vdc or within 30Vdc ~ 32Vdc, we can choose PV module with below specification.

Maximum Power (Pmax)	260W	Max. PV module numbers in series
Max. Power Voltage Vmpp(V)	30.9V	1 → 30.9 x 1 ≐ 30 ~ 32
Max. Power Current Impp(A)	8.42A	PV module numbers in parallel
Open Circuit Voltage Voc(V)	37.7V	6 → 50 A / 8.42
Short Circuit Current Isc(A)	8.89A	Total PV module numbers
		1 x 6 = 6

Maximum PV module numbers in Series: 1

PV module numbers in Parallel: 6

Total PV module numbers: 1 x 6 = 6

Take 4K/5K model inverter as an example to select proper PV module. After considering Voc of PV module not exceed 105Vdc and max. Vmpp of PV module close to 60Vdc or within 56Vdc ~ 72Vdc, we can choose PV module with below specification.

Maximum Power (Pmax)	260W	Max. PV module numbers in series
Max. Power Voltage Vmpp(V)	30.9V	2 → 30.9 x 2 ≐ 56 ~ 72
Max. Power Current Impp(A)	8.42A	PV module numbers in parallel
Open Circuit Voltage Voc(V)	37.7V	6 → 50 A / 8.42
Short Circuit Current Isc(A)	8.89A	Total PV module numbers
		2 x 6 = 12

Maximum PV module numbers in Series: 2

PV module numbers in Parallel: 6

Total PV module numbers: 2 x 6 = 12

Please follow below steps to implement PV module connection:

1. Remove insulation sleeve 10 mm for positive and negative conductors.
2. Check correct polarity of connection cable from PV modules and PV input connectors. Then, connect positive pole (+) of connection cable to positive pole (+) of PV input connector. Connect negative pole (-) of connection cable to negative pole (-) of PV input connector.

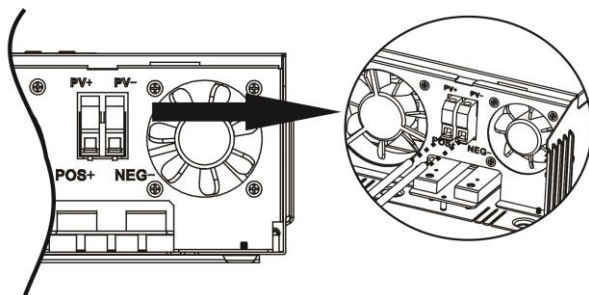
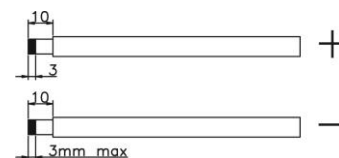

3. Make sure the wires are securely connected.

Final Assembly

After connecting all wirings, please put bottom cover back by screwing two screws as shown below.

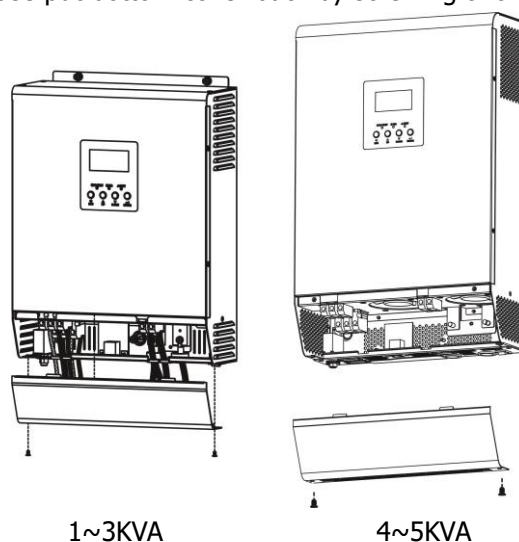

Communication Connection

Please use supplied communication cable to connect to inverter and PC. Insert bundled CD into a computer and follow on-screen instruction to install the monitoring software. For the detailed software operation, please check user manual of software inside of CD.

Dry Contact Signal

There is one dry contact (3A/250VAC) available on the rear panel. It could be used to deliver signal to external device when battery voltage reaches warning level.

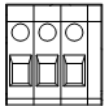
Unit Status	Condition		Dry contact port: 		
			NC & C	NO & C	
Power Off	Unit is off and no output is powered.		Close	Open	
Power On	Output is powered from Utility.		Close	Open	
	Output is powered from Battery or Solar.	Program 01 set as Utility	Battery voltage < Low DC warning voltage	Open	Close
			Battery voltage > Setting value in Program 13 or battery charging reaches floating stage	Close	Open
	Output is powered from Battery or Solar.	Program 01 is set as SBU or Solar first	Battery voltage < Setting value in Program 12	Open	Close
Battery voltage > Setting value in Program 13 or battery charging reaches floating stage			Close	Open	

OPERATION

Power ON/OFF

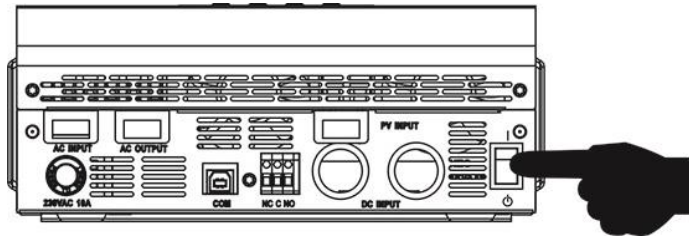

Once the unit has been properly installed and the batteries are connected well, simply press On/Off switch (located on the button of the case) to turn on the unit.

Operation and Display Panel

The operation and display panel, shown in below chart, is on the front panel of the inverter. It includes three indicators, four function keys and a LCD display, indicating the operating status and input/output power information.

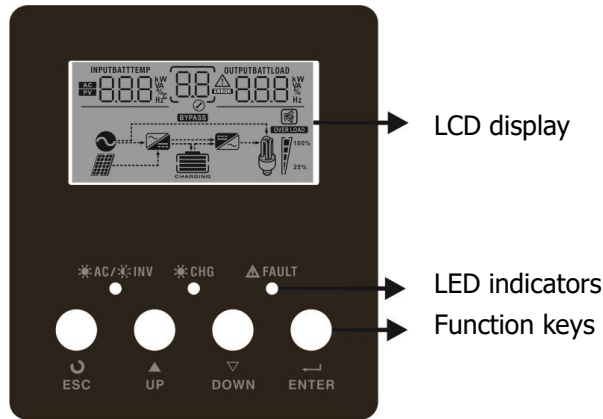

LED Indicator

LED Indicator		Messages	
☀️ AC / 🌙 INV	Green	Solid On	Output is powered by utility in Line mode.
		Flashing	Output is powered by battery or PV in battery mode.
☀️ CHG	Green	Solid On	Battery is fully charged.
		Flashing	Battery is charging.
⚠️ FAULT	Red	Solid On	Fault occurs in the inverter.
		Flashing	Warning condition occurs in the inverter.

Function Keys

Function Key	Description
ESC	To exit setting mode
UP	To go to previous selection
DOWN	To go to next selection
ENTER	To confirm the selection in setting mode or enter setting mode

LCD Display Icons

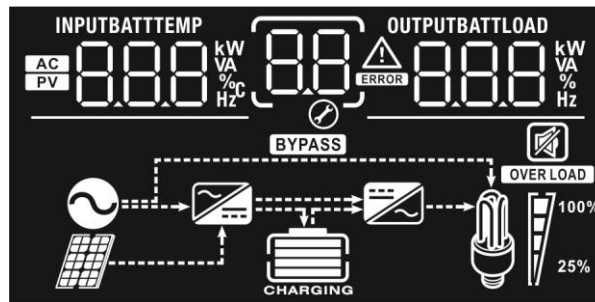

Icon	Function description	
Input Source Information		
AC	Indicates the AC input.	
PV	Indicates the PV input	
INPUTBATT 	Indicate input voltage, input frequency, PV voltage, battery voltage and charger current.	
Configuration Program and Fault Information		
	Indicates the setting programs.	
	Indicates the warning and fault codes. Warning: flashing with warning code. Fault: lighting with fault code	
Output Information		
OUTPUTBATTLOAD 	Indicate output voltage, output frequency, load percent, load in VA, load in Watt and discharging current.	
Battery Information		
	Indicates battery level by 0-24%, 25-49%, 50-74% and 75-100% in battery mode and charging status in line mode.	
In AC mode, it will present battery charging status.		
Status	Battery voltage	LCD Display
Constant Current mode / Constant Voltage mode	<2V/cell	4 bars will flash in turns.
	2 ~ 2.083V/cell	Bottom bar will be on and the other three bars will flash in turns.
	2.083 ~ 2.167V/cell	Bottom two bars will be on and the other two bars will flash in turns.
Floating mode. Batteries are fully charged.	> 2.167 V/cell	Bottom three bars will be on and the top bar will flash.
		4 bars will be on.

In battery mode, it will present battery capacity.

Load Percentage	Battery Voltage	LCD Display
Load > 50%	< 1.717V/cell	
	1.717V/cell ~ 1.8V/cell	
	1.8 ~ 1.883V/cell	
	> 1.883 V/cell	
50% > Load > 20%	< 1.817V/cell	
	1.817V/cell ~ 1.9V/cell	
	1.9 ~ 1.983V/cell	
	> 1.983	
Load < 20%	< 1.867V/cell	
	1.867V/cell ~ 1.95V/cell	
	1.95 ~ 2.033V/cell	
	> 2.033	

Load Information

	Indicates overload.			
	Indicates the load level by 0-24%, 25-50%, 50-74% and 75-100%.			
	0%~25%	25%~50%	50%~75%	75%~100%

Mode Operation Information

	Indicates unit connects to the mains.
	Indicates unit connects to the PV panel.
	Indicates load is supplied by utility power.
	Indicates the utility charger circuit is working.
	Indicates the DC/AC inverter circuit is working.

Mute Operation

	Indicates unit alarm is disabled.
--	-----------------------------------

LCD Setting

After pressing and holding ENTER button for 3 seconds, the unit will enter setting mode. Press "UP" or "DOWN" button to select setting programs. And then, press "ENTER" button to confirm the selection or ESC button to exit.

Setting Programs:

Program	Description	Selectable option	
00	Exit setting mode	Escape 00 ESC	
01	Output source priority: To configure load power source priority	Solar first 01 SOL	Solar energy provides power to the loads as first priority. If solar energy is not sufficient to power all connected loads, battery energy will supply power the loads at the same time. Utility provides power to the loads only when any one condition happens: - Solar energy is not available - Battery voltage drops to low-level warning voltage or the setting point in program 12.
		Utility first (default) 01 UTI	Utility will provide power to the loads as first priority. Solar and battery energy will provide power to the loads only when utility power is not available.
		SBU priority 01 SBU	Solar energy provides power to the loads as first priority. If solar energy is not sufficient to power all connected loads, battery energy will supply power to the loads at the same time. Utility provides power to the loads only when battery voltage drops to either low-level warning voltage or the setting point in program 12.
02	Maximum charging current: To configure total charging current for solar and utility chargers. (Max. charging current = utility charging current + solar charging current)	10A (Only available for 1K/4K/5K models) 02 10 ^A	20A 02 20 ^A
		30A 02 30 ^A	40A 02 40 ^A

		50A (default) 02 50 ^A	
		60A (Only for 4K/5K models) 02 60 ^A	70A (Only for 4K/5K models) 02 70 ^A
		80A (Only for 4K/5K models) 02 80 ^A	90A (Only for 4K/5K models) 02 90 ^A
		100A (Only for 4K/5K models) 02 100 ^A	110A (Only for 4K/5K models) 02 110 ^A
03	AC input voltage range	Appliances (default) 03 APL	If selected, acceptable AC input voltage range will be within 90-280VAC.
		UPS 03 UPS	If selected, acceptable AC input voltage range will be within 170-280VAC.
04	Power saving mode enable/disable	Saving mode disable (default) 04 SDS	If disabled, no matter connected load is low or high, the on/off status of inverter output will not be effected.
		Saving mode enable 04 SEN	If enabled, the output of inverter will be off when connected load is pretty low or not detected.
05	Battery type	AGM (default) 05 AGM	Flooded 05 FLd
		User-Defined 05 USE	If "User-Defined" is selected, battery charge voltage and low DC cut-off voltage can be set up in program 26, 27 and 29.
06	Auto restart when overload occurs	Restart disable (default) 06 Lfd	Restart enable 06 LfE
07	Auto restart when over temperature occurs	Restart disable (default) 07 tfd	Restart enable 07 tFE
09	Output frequency	50Hz (default) 09 50 ^{Hz}	60Hz 09 60 ^{Hz}



11	<p>Maximum utility charging current</p> <p>Note: If setting value in program 02 is smaller than that in program in 11, the inverter will apply charging current from program 02 for utility charger.</p>	Available options in 1K model:	
		10A 11 10A	20A (default) 11 20A
		Available options in 2K/3K model:	
		20A 11 20A	30A (default) 11 30A
		Available options in 4K/5K model:	
		2A 11 2A	10A 11 10A
		20A 11 20A	30A (default) 11 30A
		40A 11 40A	50A 11 50A
60A 11 60A			
12	<p>Setting voltage point back to utility source when selecting "SBU priority" or "Solar first" in program 01.</p>	Available options in 1K model:	
		11.0V 12 BATT 11.0v	11.3V 12 BATT 11.3v
		11.5V (default) 12 BATT 11.5v	11.8V 12 BATT 11.8v
		12.0V 12 BATT 12.0v	12.3V 12 BATT 12.3v
		12.5V 12 BATT 12.5v	12.8V 12 BATT 12.8v
		Available options in 2K/3K model:	
		22.0V 12 BATT 22.0v	22.5V 12 BATT 22.5v
		23.0V (default) 12 BATT 23.0v	23.5V 12 BATT 23.5v

		24.0V 12 ^{BATT} 24.0 _v	24.5V 12 ^{BATT} 24.5 _v
		25.0V 12 ^{BATT} 25.0 _v	25.5V 12 ^{BATT} 25.5 _v
		Available options in 4K/5K model:	
		44V 12 ^{BATT} 44 _v	45V 12 ^{BATT} 45 _v
		46V (default) 12 ^{BATT} 46 _v	47V 12 ^{BATT} 47 _v
		48V 12 ^{BATT} 48 _v	49V 12 ^{BATT} 49 _v
		50V 12 ^{BATT} 50 _v	51V 12 ^{BATT} 51 _v
		Available options in 1K model:	
		Battery fully charged 13 ^{BATT} FUL	12.0V 13 ^{BATT} 12.0 _v
		12.3V 13 ^{BATT} 12.3 _v	12.5V 13 ^{BATT} 12.5 _v
		12.8V 13 ^{BATT} 12.8 _v	13.0V 13 ^{BATT} 13.0 _v
		13.3V 13 ^{BATT} 13.3 _v	13.5V (default) 13 ^{BATT} 13.5 _v
		13.8V 13 ^{BATT} 13.8 _v	14.0V 13 ^{BATT} 14.0 _v
13	Setting voltage point back to battery mode when selecting "SBU priority" or "Solar first" in program 01.		

13	Setting voltage point back to battery mode when selecting "SBU priority" or "Solar first" in program 01.	14.3V 13 ^{BATT} 14.3 _v	14.5V 13 ^{BATT} 14.5 _v
		Available options in 2K/3K model:	
		Battery fully charged 13 ^{BATT} FUL	24V 13 ^{BATT} 24.0 _v
		24.5V 13 ^{BATT} 24.5 _v	25V 13 ^{BATT} 25.0 _v
		25.5V 13 ^{BATT} 25.5 _v	26V 13 ^{BATT} 26.0 _v
		26.5V 13 ^{BATT} 26.5 _v	27V (default) 13 ^{BATT} 27.0 _v
		27.5V 13 ^{BATT} 27.5 _v	28V 13 ^{BATT} 28.0 _v
		28.5V 13 ^{BATT} 28.5 _v	29V 13 ^{BATT} 29.0 _v
		Available options in 4K/5K model:	
		Battery fully charged 13 ^{BATT} FUL	48V 13 ^{BATT} 48.0 _v
		49V 13 ^{BATT} 49.0 _v	50V 13 ^{BATT} 50.0 _v
		51V 13 ^{BATT} 51.0 _v	52V 13 ^{BATT} 52.0 _v
		53V 13 ^{BATT} 53.0 _v	54V (default) 13 ^{BATT} 54.0 _v

		55V 13 ^{BATT} 55.0 v	56V 13 ^{BATT} 56.0 v
		57V 13 ^{BATT} 57.0 v	58V 13 ^{BATT} 58.0 v
16	Charger source priority: To configure charger source priority	If this inverter/charger is working in Line, Standby or Fault mode, charger source can be programmed as below:	
		Solar first 16 ^{BATT} C50	Solar energy will charge battery as first priority. Utility will charge battery only when solar energy is not available.
		Utility first 16 ^{BATT} CUE	Utility will charge battery as first priority. Solar energy will charge battery only when utility power is not available.
		Solar and Utility (default) 16 ^{BATT} SNU	Solar energy and utility will charge battery at the same time.
		Only Solar 16 ^{BATT} 050	Solar energy will be the only charger source no matter utility is available or not.
		If this inverter/charger is working in Battery mode or Power saving mode, only solar energy can charge battery. Solar energy will charge battery if it's available and sufficient.	
18	Alarm control	Alarm on (default) 18 ^{BATT} 60N	Alarm off 18 ^{BATT} 60F
19	Auto return to default display screen	Return to default display screen (default) 19 ^{BATT} ESP	If selected, no matter how users switch display screen, it will automatically return to default display screen (Input voltage /output voltage) after no button is pressed for 1 minute.
		Stay at latest screen 19 ^{BATT} FEP	If selected, the display screen will stay at latest screen user finally switches.
20	Backlight control	Backlight on (default) 20 ^{BATT} LON	Backlight off 20 ^{BATT} LOF
22	Beeps while primary source is interrupted	Alarm on (default) 22 ^{BATT} AON	Alarm off 22 ^{BATT} AOF

23	Overload bypass: When enabled, the unit will transfer to line mode if overload occurs in battery mode.	Bypass disable (default) 23 byd	Bypass enable 23 byE
25	Record Fault code	Record enable 25 FEN	Record disable (default) 25 FdS
26	Bulk charging voltage (C.V voltage)	<p>1KVA default setting: 14.1V CU 26 BATT 14.1^v</p> <p>2K/3KVA default setting: 28.2V CU 26 BATT 28.2^v</p> <p>4K/5KVA default setting: 56.4V CU 26 BATT 56.4^v</p> <p>If self-defined is selected in program 5, this program can be set up. Setting range is from 12.0V to 14.6V for 1K model, 24.0V to 29.2V for 2K/3K model and 48.0V to 58.4V for 4K/5K model. Increment of each click is 0.1V.</p>	
27	Floating charging voltage	<p>1KVA default setting: 13.5V FLU 27 BATT 13.5^v</p> <p>2K/3KVA default setting: 27.0V FLU 27 BATT 27.0^v</p> <p>4K/5KVA default setting: 54.0V FLU 27 BATT 54.0^v</p> <p>If self-defined is selected in program 5, this program can be set up. Setting range is from 12.0V to 14.6V for 1K model, 24.0V to 29.2V for 2K/3K model and 48.0V to 58.4V for 4K/5K model. Increment of each click is 0.1V.</p>	

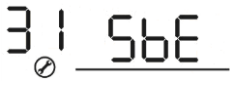
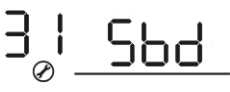
29	Low DC cut-off voltage	1KVA default setting: 10.5V	
			
		2K/3KVA default setting: 21.0V	
			
		4K/5KVA default setting: 42.0V	
			
		<p>If self-defined is selected in program 5, this program can be set up. Setting range is from 10.0V to 12.0V for 1K model, 20.0V to 24.0V for 2K/3K model and 40.0V to 48.0V for 4K/5K model. Increment of each click is 0.1V. Low DC cut-off voltage will be fixed to setting value no matter what percentage of load is connected.</p>	
31	Solar power balance: When enabled, solar input power will be automatically adjusted according to connected load power. (Only available for 4KVA/5KVA model)	Solar power balance enable (Default):	If selected, solar input power will be automatically adjusted according to the following formula: Max. input solar power = Max. battery charging power + Connected load power.
			
		Solar power balance disable:	If selected, the solar input power will be the same to max. battery charging power no matter how much loads are connected. The max. battery charging power will be based on the setting current in program 02. (Max. solar power = Max. battery charging power)
			

Display Setting

The LCD display information will be switched in turns by pressing "UP" or "DOWN" key. The selectable information is switched as below order: input voltage, input frequency, PV voltage, charging current, battery voltage, output voltage, output frequency, load percentage, load in Watt, load in VA, load in Watt, DC discharging current, main CPU Version and second CPU Version.



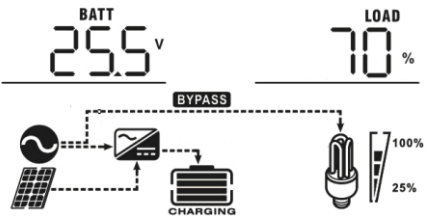
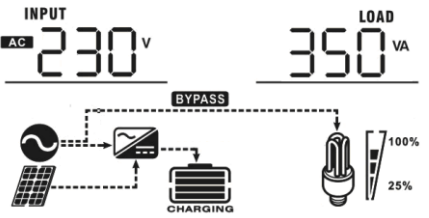
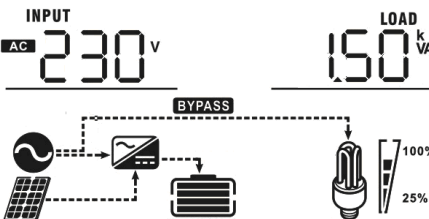
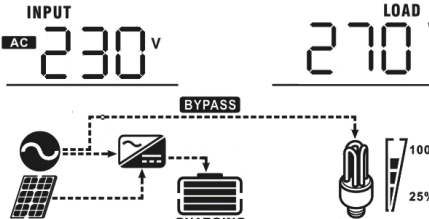
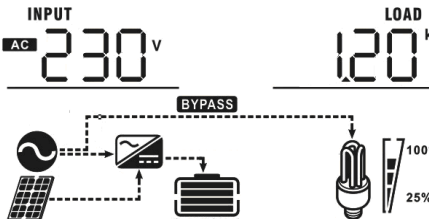
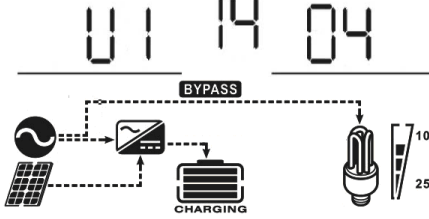

Selectable information	LCD display
Input voltage/Output voltage (Default Display Screen)	<p>Input Voltage=230V, output voltage=230V</p>
Input frequency	<p>Input frequency=50Hz</p>
PV voltage	<p>PV voltage=60V</p>
Charging current	<p>Charging current=50A</p>
Battery voltage/ DC discharging current	<p>Battery voltage=25.5V, discharging current=1A</p>
Output frequency	<p>Output frequency=50Hz</p>

<p>Load percentage</p>	<p>Load percent=70%</p> 
<p>Load in VA</p>	<p>When connected load is lower than 1kVA, load in VA will present xxxVA like below chart.</p>  <p>When load is larger than 1kVA ($\geq 1\text{kVA}$), load in VA will present x.xkVA like below chart.</p> 
<p>Load in Watt</p>	<p>When load is lower than 1kW, load in W will present xxxW like below chart.</p>  <p>When load is larger than 1kW ($\geq 1\text{kW}$), load in W will present x.xkW like below chart.</p> 
<p>Main CPU version checking</p>	<p>Main CPU version 00014.04</p> 

<p>Secondary CPU version checking</p>	<p>Secondary CPU version 00003.03</p> <p style="font-size: 2em; text-align: center;">U2 03 03</p> <hr/>
---------------------------------------	---

Operating Mode Description

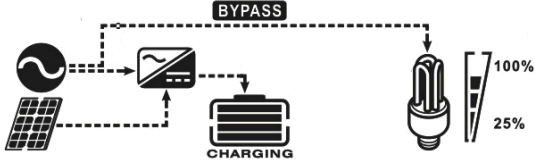
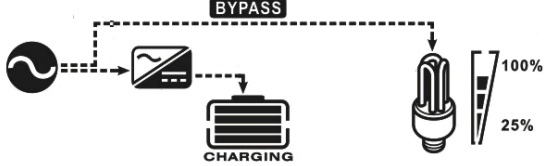
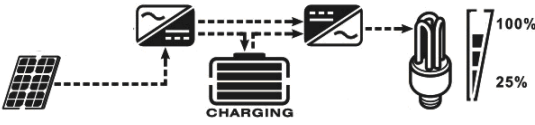
Operation mode	Description	LCD display
<p>Standby mode / Power saving mode</p> <p>Note:</p> <p>*Standby mode: The inverter is not turned on yet but at this time, the inverter can charge battery without AC output.</p> <p>*Power saving mode: If enabled, the output of inverter will be off when connected load is pretty low or not detected.</p>	<p>No output is supplied by the unit but it still can charge batteries.</p>	<p>Charging by utility and PV energy.</p>
		<p>Charging by utility.</p>
		<p>Charging by PV energy.</p>
		<p>No charging.</p>
<p>Fault mode</p> <p>Note:</p> <p>*Fault mode: Errors are caused by inside circuit error or external reasons such as over temperature, output short circuited and so on.</p>	<p>PV energy and utility can charge batteries.</p>	<p>Charging by utility and PV energy. (Only available in 1K/2K/3K model)</p>
		<p>Charging by utility. (Only available in 1K/2K/3K model)</p>
		<p>Charging by PV energy.</p>

Operation mode	Description	LCD display
Fault mode Note: *Fault mode: Errors are caused by inside circuit error or external reasons such as over temperature, output short circuited and so on.	PV energy and utility can charge batteries.	No charging. 
	Utility can power loads when the unit starts up without battery. (Only available in 4K/5K model with single operation)	Power from utility 
Line Mode	The unit will provide output power from the mains. It will also charge the battery at line mode.	Charging by utility and PV energy. 
		Charging by utility. 
Battery Mode	The unit will provide output power from battery and PV power.	Power from battery and PV energy. 
		Power from battery only. 

Fault Reference Code

Fault Code	Fault Event	Icon on
01	Fan is locked when inverter is off.	
02	Over temperature	
03	Battery voltage is too high	
04	Battery voltage is too low	
05	Output short circuited or over temperature is detected by internal converter components.	
06	Output voltage is abnormal. (For 1K/2K/3K model) Output voltage is too high. (For 4K/5K model)	
07	Overload time out	
08	Bus voltage is too high	
09	Bus soft start failed	
11	Main relay failed	
51	Over current or surge	
52	Bus voltage is too low	
53	Inverter soft start failed	
55	Over DC voltage in AC output	
56	Battery connection is open	
57	Current sensor failed	
58	Output voltage is too low	

NOTE: Fault codes 51, 52, 53, 55, 56, 57 and 58 are only available in 4K/5K model.

Warning Indicator

Warning Code	Warning Event	Audible Alarm	Icon flashing
01	Fan is locked when inverter is on.	Beep three times every second	
03	Battery is over-charged	Beep once every second	
04	Low battery	Beep once every second	
07	Overload	Beep once every 0.5 second	
10	Output power derating	Beep twice every 3 seconds	

SPECIFICATIONS

Table 1 Line Mode Specifications

INVERTER MODEL	1KVA	2KVA	3KVA	4KVA	5KVA
Input Voltage Waveform	Sinusoidal (utility or generator)				
Nominal Input Voltage	230Vac				
Low Loss Voltage	170Vac±7V (UPS); 90Vac±7V (Appliances)				
Low Loss Return Voltage	180Vac±7V (UPS); 100Vac±7V (Appliances)				
High Loss Voltage	280Vac±7V				
High Loss Return Voltage	270Vac±7V				
Max AC Input Voltage	300Vac				
Nominal Input Frequency	50Hz / 60Hz (Auto detection)				
Low Loss Frequency	40±1Hz				
Low Loss Return Frequency	42±1Hz				
High Loss Frequency	65±1Hz				
High Loss Return Frequency	63±1Hz				
Output Short Circuit Protection	Circuit Breaker				
Efficiency (Line Mode)	>95% (Rated R load, battery full charged)				
Transfer Time	10ms typical (UPS); 20ms typical (Appliances)				
<p>Output power derating: When AC input voltage drops to 170V, the output power will be derated.</p>	<p>The graph illustrates the output power derating characteristics. The vertical axis represents Output Power, with two specific levels marked: 50% Power and Rated Power. The horizontal axis represents Input Voltage, with three key points marked: 90V, 170V, and 280V. The power output is zero for input voltages below 90V. At 90V, the output power rises to 50% of the rated power. Between 90V and 170V, the output power increases linearly until it reaches the Rated Power level. From 170V to 280V, the output power remains constant at the Rated Power level. Beyond 280V, the output power drops to zero.</p>				

Table 2 Inverter Mode Specifications

INVERTER MODEL	1KVA	2KVA	3KVA	4KVA	5KVA
Rated Output Power	1kVA/1kW	2kVA/2kW	3kVA/3kW	4kVA/4kW	5kVA/5kW
Output Voltage Waveform	Pure Sine Wave				
Output Voltage Regulation	230Vac±5%				
Output Frequency	50Hz				
Peak Efficiency	90%				
Overload Protection	5s@≥150% load; 10s@110%~150% load				
Surge Capacity	2* rated power for 5 seconds				
Nominal DC Input Voltage	12Vdc	24Vdc		48Vdc	
Cold Start Voltage	11.5Vdc	23.0Vdc		46.0Vdc	
Low DC Warning Voltage					
@ load < 20%	11.0Vdc	22.0Vdc		44.0Vdc	
@ 20% ≤ load < 50%	10.7Vdc	21.4Vdc		42.8Vdc	
@ load ≥ 50%	10.1Vdc	20.2Vdc		40.4Vdc	
Low DC Warning Return Voltage					
@ load < 20%	11.5Vdc	23.0Vdc		46.0Vdc	
@ 20% ≤ load < 50%	11.2Vdc	22.4Vdc		44.8Vdc	
@ load ≥ 50%	10.6Vdc	21.2Vdc		42.4Vdc	
Low DC Cut-off Voltage					
@ load < 20%	10.5Vdc	21.0Vdc		42.0Vdc	
@ 20% ≤ load < 50%	10.2Vdc	20.4Vdc		40.8Vdc	
@ load ≥ 50%	9.6Vdc	19.2Vdc		38.4Vdc	
High DC Recovery Voltage	14.5Vdc	29Vdc		58Vdc	
High DC Cut-off Voltage	15.5Vdc	31Vdc		60Vdc	
No Load Power Consumption	<15W	<20W		<50W	
Saving Mode Power Consumption	<5W	<10W		<15W	

Table 3 Charge Mode Specifications

INVERTER MODEL		1KVA	2KVA	3KVA	4KVA	5KVA
Charging Algorithm		3-Step				
Utility Charging Mode						
AC Charging Current		10/20Amp	20/30Amp (@ $V_{I/P}=230V_{ac}$)		2/10/20/30/40/50/60Amp (@ $V_{I/P}=230V_{ac}$)	
Bulk Charging Voltage	Flooded Battery	14.6	29.2		58.4	
	AGM / Gel Battery	14.1	28.2		56.4	
Floating Charging Voltage		13.5Vdc	27Vdc		54Vdc	
Charging Curve						
Solar Charging Mode						
Charging Current (PWM)		50Amp				
System DC Voltage		12Vdc	24Vdc		48Vdc	
Operating Voltage Range		15~18Vdc	30~32Vdc		60~72vdc	
Max. PV Array Open Circuit Voltage		50Vdc	60Vdc		90Vdc	
Standby Power Consumption		1W	2W			
DC Voltage Accuracy		+/-0.3%				
Joint Utility and Solar Charging						
INVERTER MODEL		1KVA	2KVA	3KVA	4KVA	5KVA
Max Charging Current		50Amp			110Amp	
Default Charging Current		50Amp			50Amp	

Table 4 General Specifications

INVERTER MODEL	1KVA	2KVA	3KVA	4KVA	5KVA
Safety Certification	CE				
Operating Temperature Range	0°C to 55°C				
Storage temperature	-15°C~ 60°C				
Dimension (W*H*D), mm	240 x 316 x 95	272 x 355 x 100		295 x 455 x 155	
Net Weight, kg	5.0	6.5	7.0	9.8	

TROUBLE SHOOTING

Problem	LCD/LED/Buzzer	Explanation / Possible cause	What to do
Unit shuts down automatically during startup process.	LCD/LEDs and buzzer will be active for 3 seconds and then complete off.	The battery voltage is too low (<1.91V/Cell)	1. Re-charge battery. 2. Replace battery.
No response after power on.	No indication.	1. The battery voltage is far too low. (<1.4V/Cell) 2. Battery polarity is connected reversed.	1. Check if batteries and the wiring are connected well. 2. Re-charge battery. 3. Replace battery.
Mains exist but the unit works in battery mode.	Input voltage is displayed as 0 on the LCD and green LED is flashing.	Input protector is tripped	Check if AC breaker is tripped and AC wiring is connected well.
	Green LED is flashing.	Insufficient quality of AC power. (Shore or Generator)	1. Check if AC wires are too thin and/or too long. 2. Check if generator (if applied) is working well or if input voltage range setting is correct. (UPS→Appliance)
	Green LED is flashing.	Set "Solar First" as the priority of output source.	Change output source priority to Utility first.
When the unit is turned on, internal relay is switched on and off repeatedly.	LCD display and LEDs are flashing	Battery is disconnected.	Check if battery wires are connected well.
Buzzer beeps continuously and red LED is on.	Fault code 07	Overload error. The inverter is overload 110% and time is up.	Reduce the connected load by switching off some equipment.
	Fault code 05	Output short circuited.	Check if wiring is connected well and remove abnormal load.
		Temperature of internal converter component is over 120°C. (Only available for 1-3KVA models)	Check whether the air flow of the unit is blocked or whether the ambient temperature is too high.
	Fault code 02	Internal temperature of inverter component is over 100°C.	
	Fault code 03	Battery is over-charged.	Return to repair center.
		The battery voltage is too high.	Check if spec and quantity of batteries are meet requirements.
	Fault code 01	Fan fault	Replace the fan.
	Fault code 06/58	Output abnormal (Inverter voltage below than 190Vac or is higher than 260Vac)	1. Reduce the connected load. 2. Return to repair center
	Fault code 08/09/53/57	Internal components failed.	Return to repair center.
	Fault code 51	Over current or surge.	Restart the unit, if the error happens again, please return to repair center.
	Fault code 52	Bus voltage is too low.	
Fault code 55	Output voltage is unbalanced.		
Fault code 56	Battery is not connected well or fuse is burnt.	If the battery is connected well, please return to repair center.	

Appendix: Approximate Back-up Time Table (Ref.)

Model	Load (VA)	Backup Time @ 12Vdc 100Ah (min)	Backup Time @ 12Vdc 200Ah (min)
1KVA	100	766	1610
	200	335	766
	300	198	503
	400	139	339
	500	112	269
	600	95	227
	700	81	176
	800	62	140
	900	55	125
	1000	50	112

Model	Load (VA)	Backup Time @ 24Vdc 100Ah (min)	Backup Time @ 24Vdc 200Ah (min)
2KVA	200	766	1610
	400	335	766
	600	198	503
	800	139	339
	1000	112	269
	1200	95	227
	1400	81	176
	1600	62	140
	1800	55	125
	2000	50	112
3KVA	300	449	1100
	600	222	525
	900	124	303
	1200	95	227
	1500	68	164
	1800	56	126
	2100	48	108
	2400	35	94
	2700	31	74
	3000	28	67

Model	Load (VA)	Backup Time @ 48Vdc 100Ah (min)	Backup Time @ 48Vdc 200Ah (min)
4KVA	400	766	1610
	800	335	766
	1200	198	503
	1600	139	339
	2000	112	269
	2400	95	227
	2800	81	176
	3200	62	140
	3600	55	125
	4000	50	112

Model	Load (VA)	Backup Time @ 48Vdc 100Ah (min)	Backup Time @ 48Vdc 200Ah (min)
5KVA	500	613	1288
	1000	268	613
	1500	158	402
	2000	111	271
	2500	90	215
	3000	76	182
	3500	65	141
	4000	50	112
	4500	44	100
	5000	40	90

Note: Backup time depends on the quality of the battery, age of battery and type of battery.
Specifications of batteries may vary depending on different manufacturers.